

Home learning for week beginning 7th December 2020

Dear parents and carers,

This week we are thinking about writing an alternative ending to the class story 'I love you Blue Kangaroo' that we read last week. Ask your child to think about what could have happened differently. Talk about words that signal the end of a story e.g. finally, last, in the end etc.

Draw a picture of the ending e.g. Lily giving her kangaroo to her brother and write a caption.

In maths this week we are concentrating on weight and measure. Ask your child to find objects around the home and sort them into heavy and light. If you have a scale let your child experiment with the various objects and see that the heavy ones make the scale go down.

In Topic we are talking about the Christmas story. There is a nativity activity for your child to cut and stick out their own festive scene.

We are continuing to write labels and captions in Phonics. Please practise the sounds at home and spotting sounds in the environment (billboards/ads etc)

Happy learning!

<https://www.youtube.com/watch?v=FrTFAZPQxpE>

07/12/2020

LO: To use everyday language to talk about weight.

Light or Heavy?

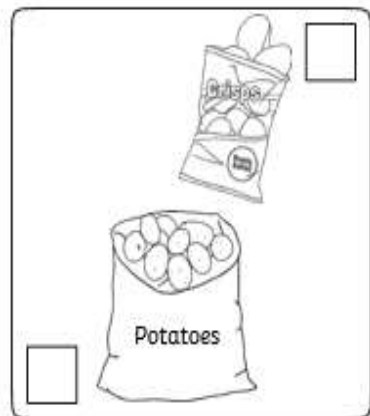
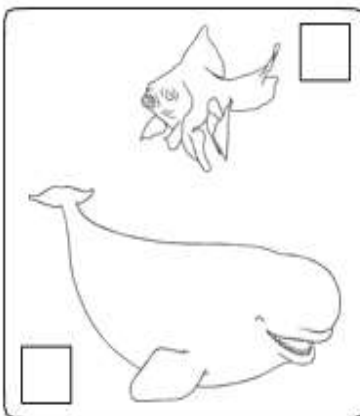
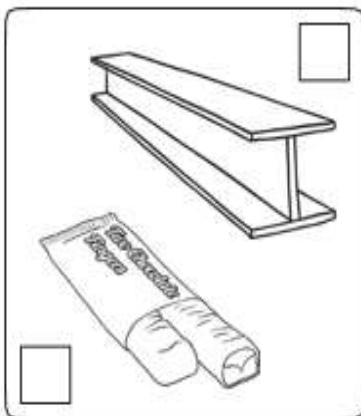
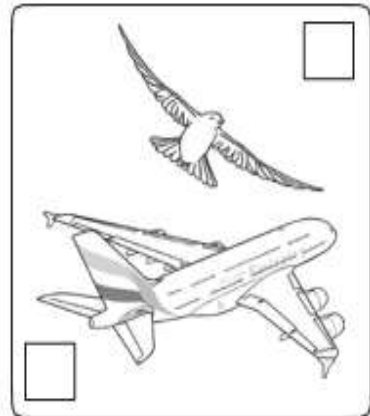
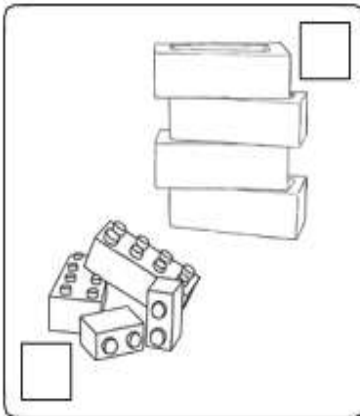
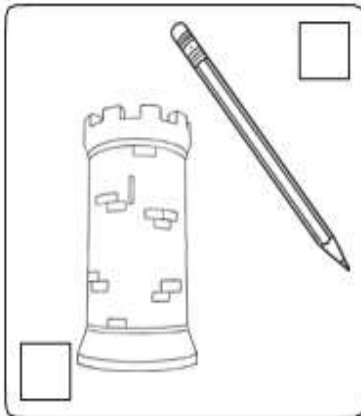
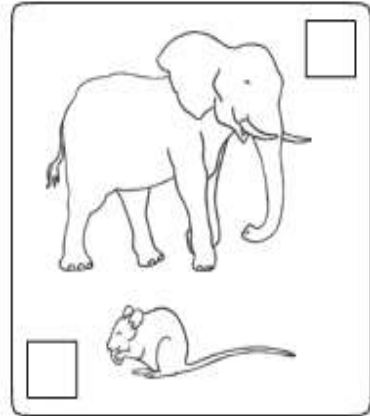
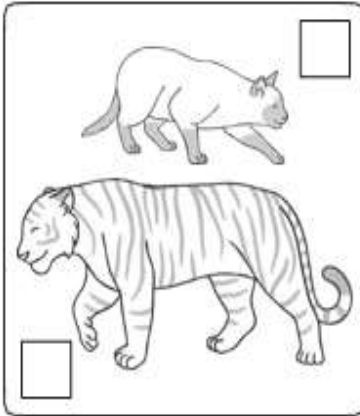
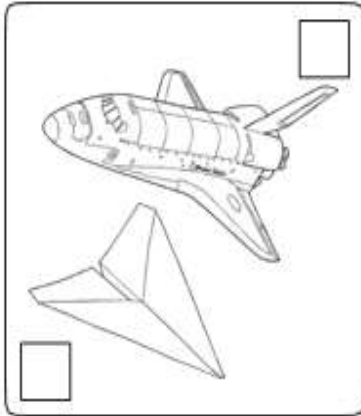

Body Cut Outs

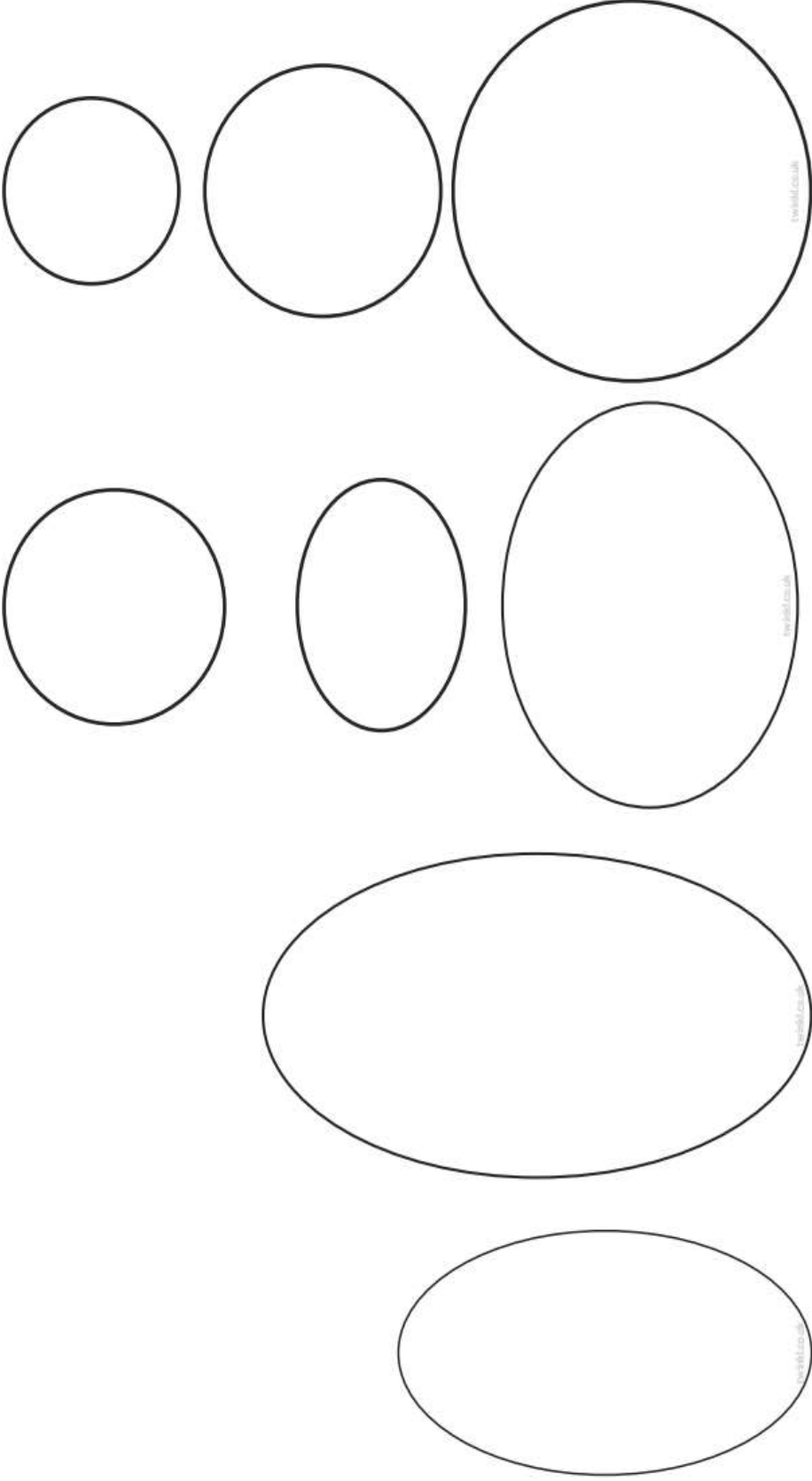

Accessories

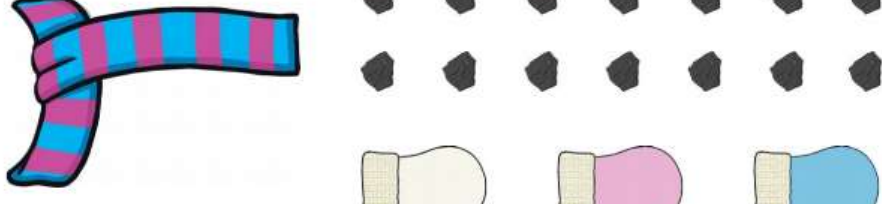
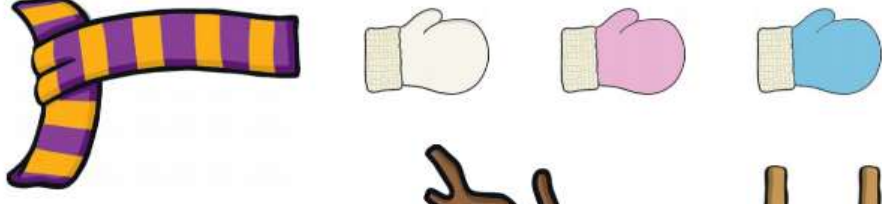

07/12/2020

To be able to write an alternative ending.

We have been reading the story 'I love you Blue Kangaroo' and we have decided to change the ending to the story.

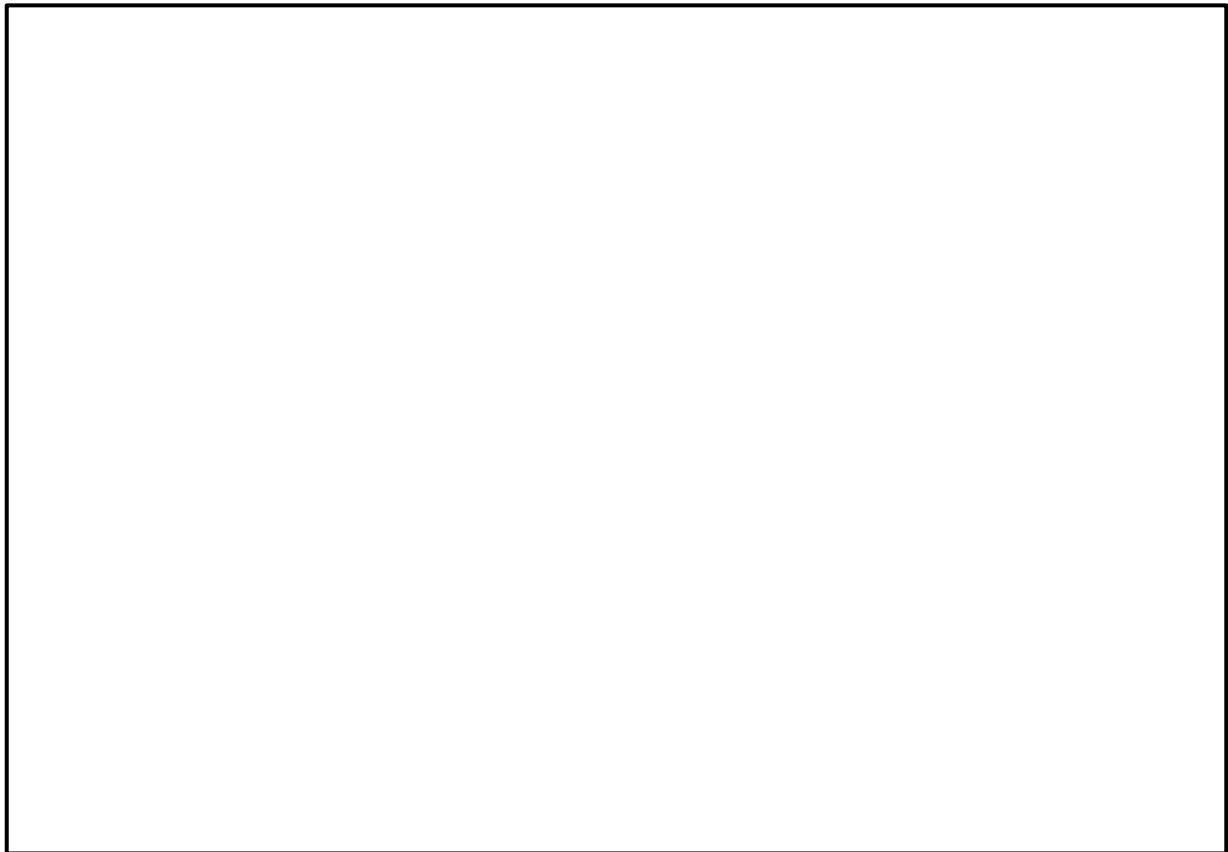

The Nativity

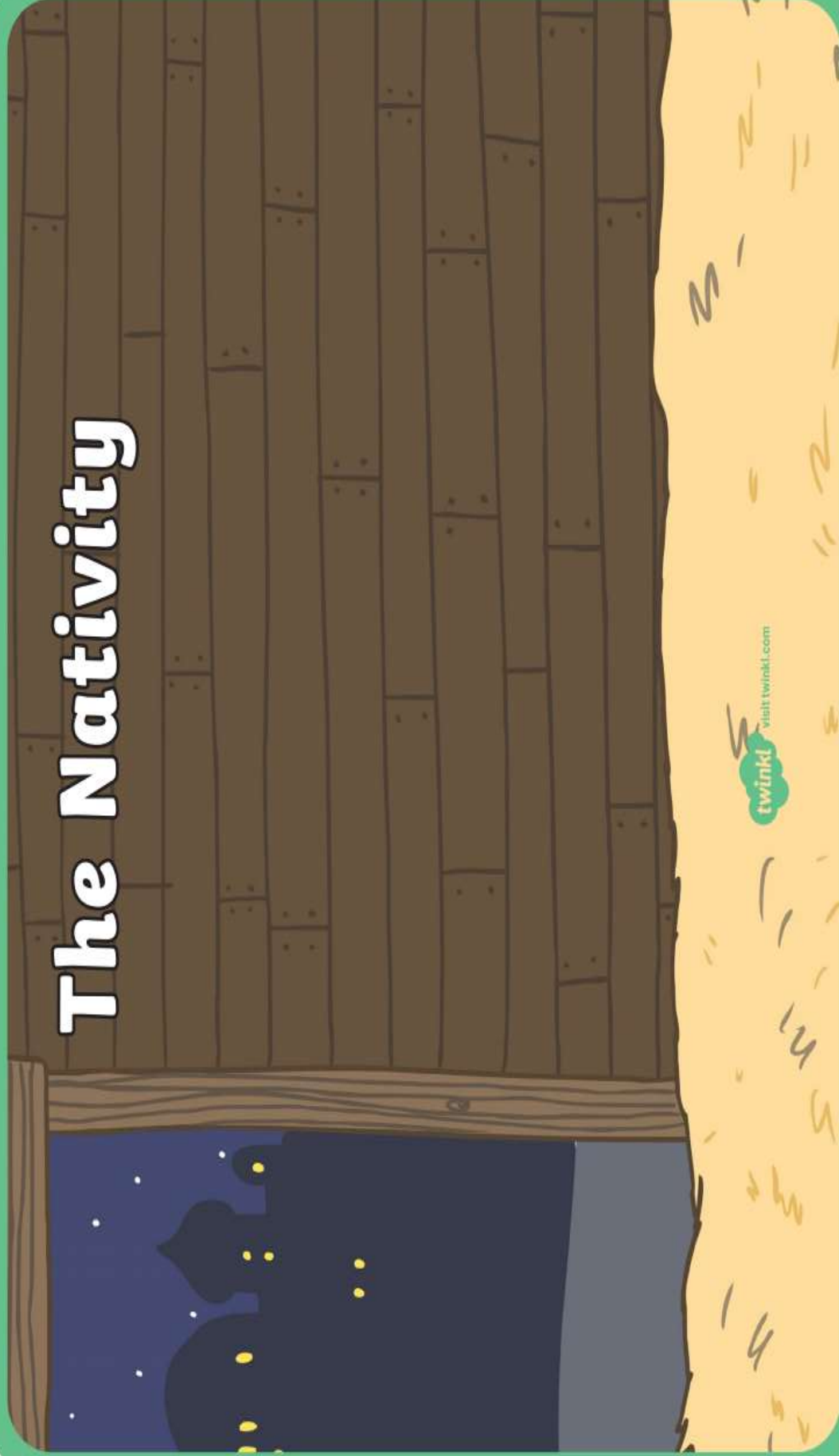



Twelve Days of Christmas Subtraction Sheets

Write the answer to the subtraction in the circle



$$- 2 =$$



Partridge in
a Pear-Tree



$$- 1 =$$



Turtle Doves



$$- 2 =$$



French Hens



$$- =$$



Calling
Birds

Christmas Missing Numbers (0-20)

1 3 4 5 8 10

11 12 15 16 18 20